

股票代號：6568

# 宏觀微電子股份有限公司



# Safe Harbor Statement

Except for historical information contained herein, the matters set forth in this presentation are forward looking statements that are subject to risks and uncertainties that could cause actual results to differ materially, including the impact of competitive products and pricing, timely design acceptance by our customers, timely introduction of new technologies, ability to ramp new products into volume, industry wide shifts in supply and demand for semiconductor products, industry overcapacity, availability of manufacturing capacity, financial stability in end markets, and other risks.

# 主要產品-寬頻RF晶片

HDTV  
RF Receiver IC

1



3  
Satellite TV Signal  
Reception & Distribution



2  
Terrestrial & Cable STB  
RF Receiver IC



4  
CATV Optical Receiver



## 財務績效指標

- Invest technology and manage effectively to maximize long term gross margin, operating margin and net profit margin.

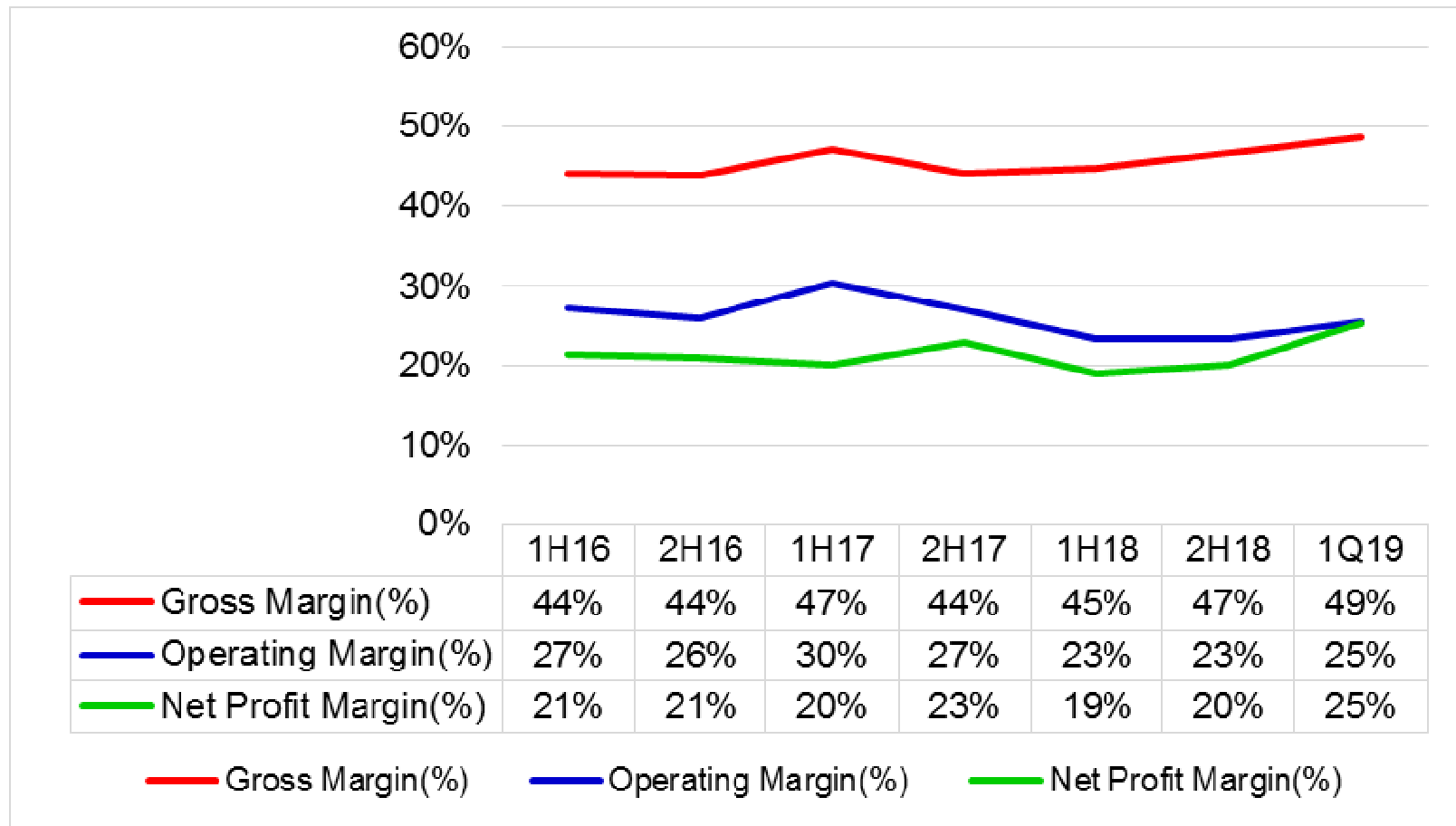

# 產品線之營收- 2017 vs 2018

- Component shortage caused business noise in 2017/2018.
- SAT business continue growth in 2018.

Revenue Proportion For the Year 2017

■ TV ■ STB ■ SAT

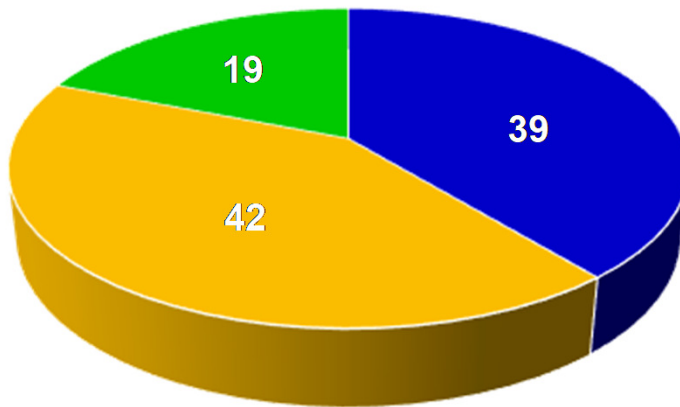

Total Rev. for the Year 2017=NT\$1,110,761K

Revenue Proportion For the Year 2018

■ TV ■ STB ■ SAT ■ Others

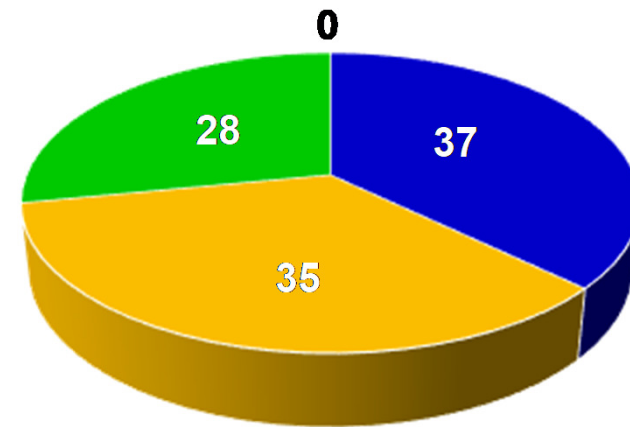

Total Rev. for the Year 2018=NT\$1,118,302K

# 產品線之營收- 1Q18 vs 1Q19

- Better product mix results record high gross margin.
- SAT business continues to win market share.
- Optical fiber becomes new revenue momentum.

Revenue Proportion for 1Q18

■ TV ■ STB ■ SAT ■ Optical ■ Others

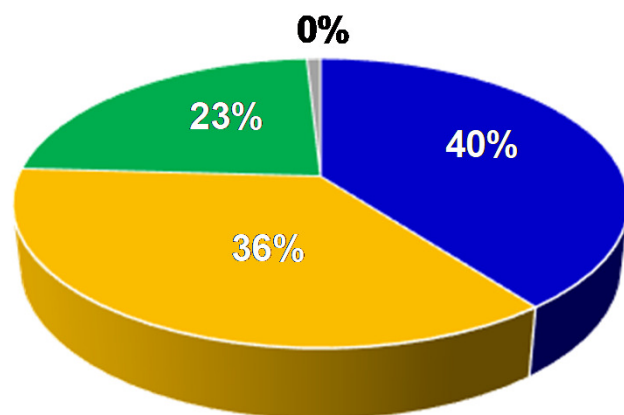

Total Rev. for 1Q18=NT\$ 259,469K

Revenue Proportion for 1Q19

■ TV ■ STB ■ SAT ■ Optical

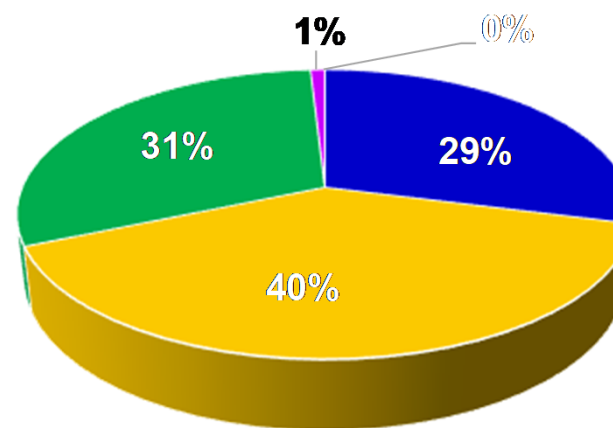

Total Rev. for 1Q19=NT\$ 283,173K

## 2019年前四月營收年成長13%

- Foresee no component shortage factor in 2019.
- More new product ramp up in 4Q19.

Unit:NT\$K ; %

Revenue	Four Months Ended April 30th		YOY(%)
	2018	2019	
TV	133,334	126,600	(5)
STB	117,927	143,295	22
SAT	88,053	112,348	28
OPTICAL	114	3,653	3,104
Others	2,252	0	(100)
Total	341,680	385,896	13

## 公司聚焦之產業趨勢

- High Definition Display 4K/8K
- High Data-rate Transmission Fiber Optics
- Massive Wireless Connectivity IoT



## 電視矽晶調諧器產業之領導廠商

- Continue to be the largest TV silicon tuner supplier in Greater China.
- Shipping ISDB-S3 (Tokyo Olympic) 4K/8K TV silicon tuner for 49"~80" TV in more than 10 models!



# 與主晶片廠商堅實的夥伴關係



(Partner Logo按照英文字母排序)



## 亞洲最大的機上盒RF晶片供應商

- Keep as the largest STB tuner supplier in China market.
- Dominate China ARFT (Administration of Radio Film and Television, 廣電) DVB-C STB tenders.
- Win majority business opportunities of Russia analog-digital signal switch over.



# 應用於 Broadcom Platform 的高頻RF晶片

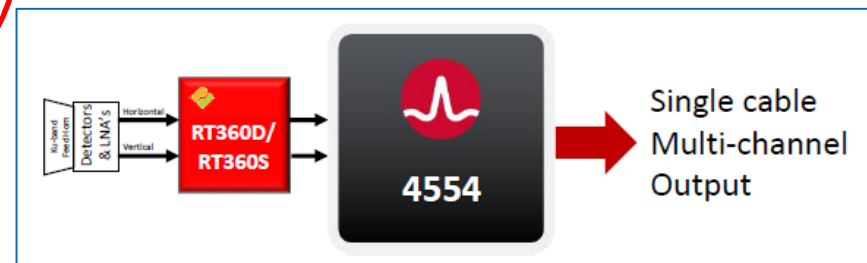
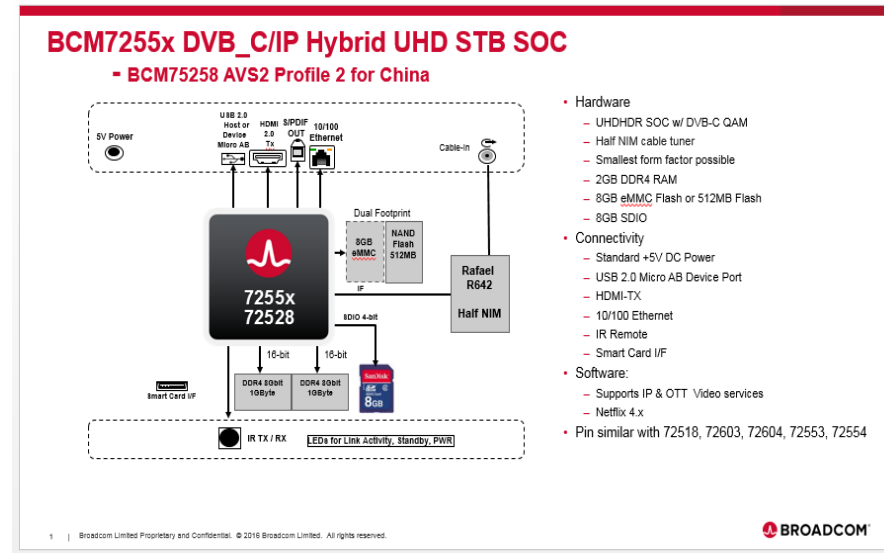
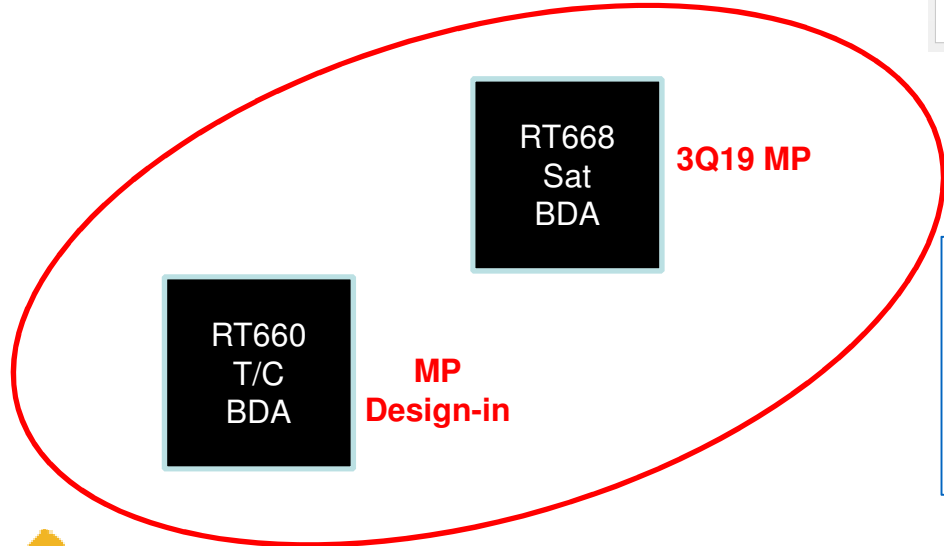

# 應用於衛星廣播的RF晶片

- Market leader in high-end twin and quad LNB ICs.
- Ramping up high margin products & specified ICs with better margin and profit .

	2017	2018	1Q19
QTY	15M	26M	7M



# 應用於光纖到戶的CATV光接收機

- Shipping Optical Receiver to China's FTTH 4K broadcast ecosystem.
- Penetrate over 45% opportunity of China ARFT (Administration of Radio Film and Television, 廣電) tender in 2019.

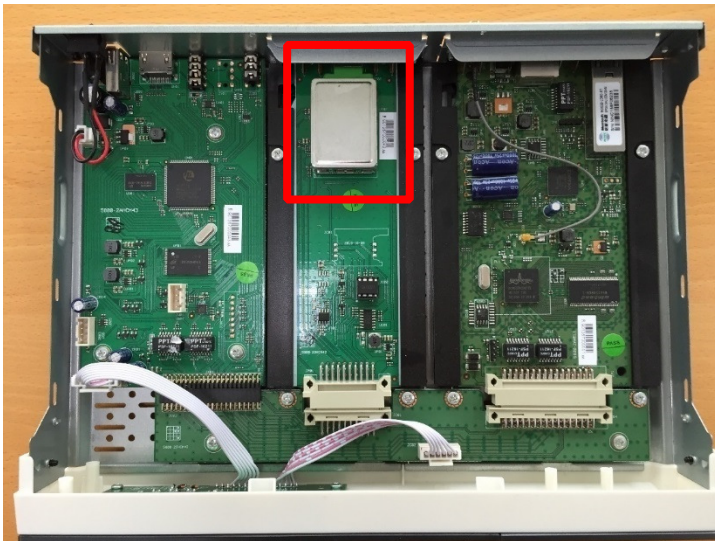

# 光纖應用市場商機再現

Target Data Center, 5G, FTTx and HDMI AOC markets



Optical Network



Base Station

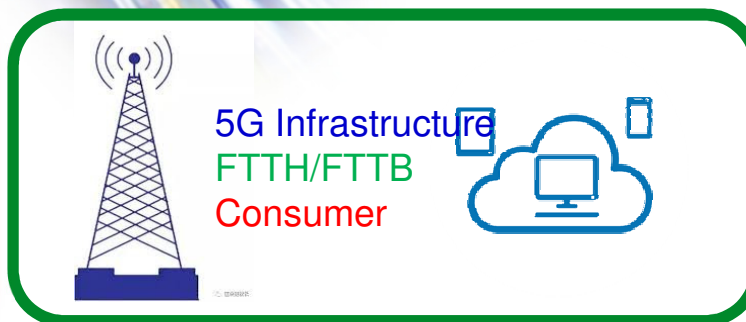

# 超高清顯示器之商機

- HDMI active optical cable (AOC) provides fast and high quality display.
- For indoor/out door digital signage, 4K/8K TV, medical image display, gaming console applications
- Rafael Micro is delivering HDMI AOC IC engineering samples to partners.

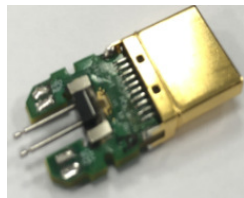

HD Video Conference



Home Theater



Live Video Transmission



Multimedia Classrooms



Outdoor Media Display



Digital Signage



Medical Imaging Transmissior



Flight Information Display



Live Video Transmission



Command and Control Center  
Video Transmission



Gaming Console

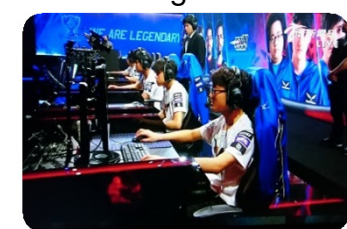



# 無線藍芽IoT之應用持續增溫

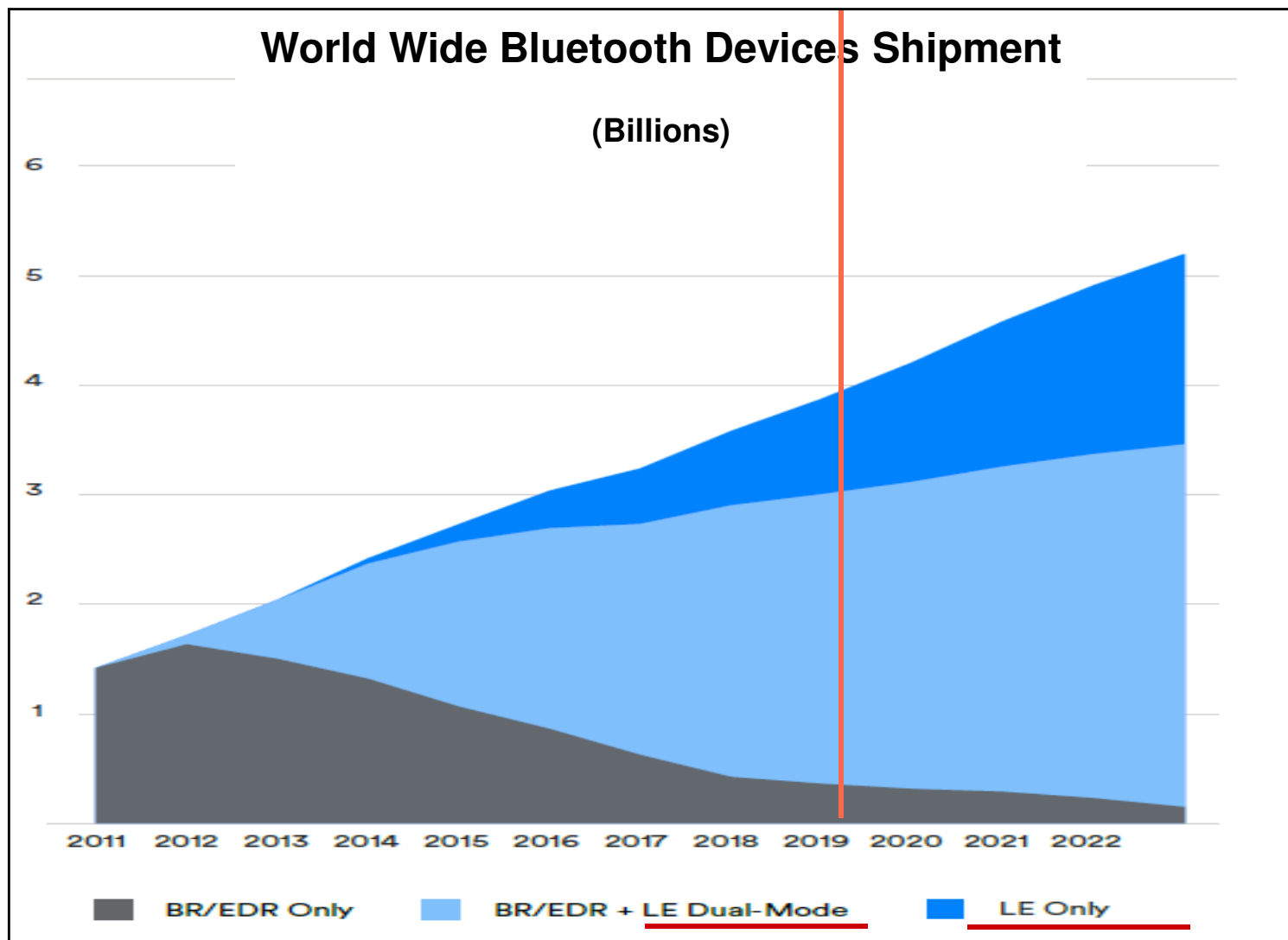

# 擁抱 IoT 智慧聯網之商機

## RT568

Bluetooth 5.0 RF  
Transceiver IC  
with Security features

**Trial in various customers' sites  
Start Shipment in 3Q19**

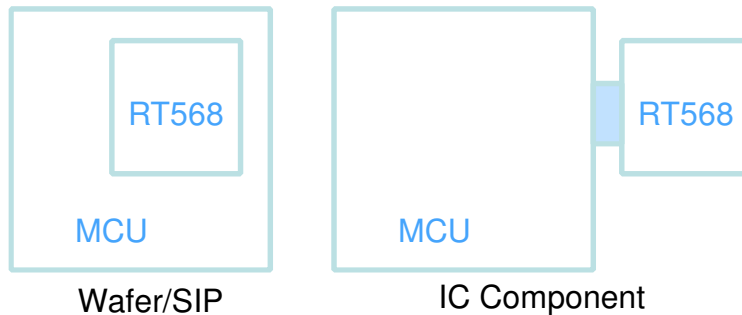

### *Bluetooth LE 5.0 SPI Transceiver with Higher PA Power and Security Features*

#### ■ Major Applications

- Smart Home
- Remote Control
- Short-Distance Firmware Update
- Smart Building
- Smart Manufacturing
- Smart Metering
- Mesh IoT network
- Misc. IoT smart devices

#### ■ Customers

- Major MCU vendors
- System Houses
- Solution Providers

# 拓展 IoT 智慧聯網之商機

**RT569**

Bluetooth 5.0 RF and Sub G  
Transceiver IC

**Trial in various customers' sites  
Start Shipment in 1Q20**

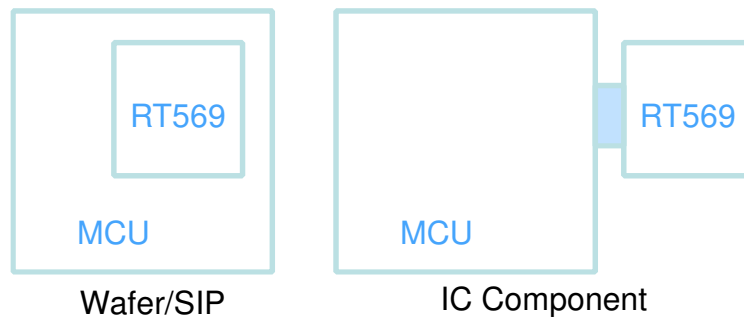

**Bluetooth LE 5.0 with Sub-G SPI Transceiver with Higher PA Power**

## ■ Major Applications

- LPWAN
- Smart Metering
- Short-Distance Firmware Update
- Smart Manufacturing

## ■ Customers

- State-Grid Related SI
- System Houses
- Solution Providers
- Major MCU vendors

Q and A